

PRODUCT SHEET

REV 0.0 - IT202502

560 SAN MARCO



ORGANIZATION WITH QUALITY MANAGEMENT SYSTEM
 ISO 9001:2015 CERTIFIED by
 EuCI European Certification Institute LTD
 Certificate N.: GOTT2532Q1902

ORGANIZATION WITH ENVIRONMENTAL MANAGEMENT SYSTEM
 ISO 14001:2015 CERTIFIED by
 EuCI European Certification Institute LTD
 Certificate No: GOTT2532E1801



WALK/BALANCE



INTERACTIVE GAME



CLIMBING



SWINGING

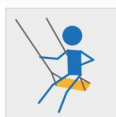







SLIDING

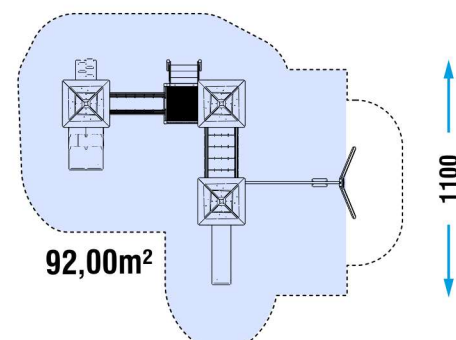

SECURITY AREA

1250



	CATALOG COLLECTION	CLASSIC COLLECTION
	DIMENSIONS (L x W x H) in cm	945 x 725 x 360 cm
	IMPACT AREA	83,50 m ²
	MAXIMUM CFH	145 cm
	SUGGESTED AGE OF USE	3+
	NUMBER OF USERS	22

COMPOSITION

- n° 14 90x90 square section timber or aluminium structural posts
- n° 4 decks with powder-coated metal frame and timber or aluminium slats
- n° 3 pyramid roof in rotational mold PTE
- n° 3 recycled HDPE and metal guard panels
- n° 3 roto-molded PTE and metal sheet guard panels
- n° 1 open metal guard panel
- n° 1 roto-molded PTE climbing
- n° 1 stairs with recycled anti-slip HDPE steps
- n° 1 «ARCO» bridge
- n° 1 «CORDE» bridge
- n° 1 roto-molded PTE modular slide (H145)
- n° 1 roto-molded PTE double modular slide (H100)
- n° 2 HDPE thrust bearings
- n° 1 swing

PLAY PANELS
LUDIC PLAY PANEL
x1

MUSICAL PLAY PANEL
x1

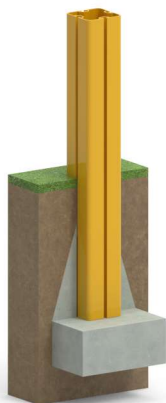
EDUCATIONAL PLAY PANEL
x1
INSTALLATION

Where there is an aluminum pole, the plinth must be created directly on it.



If there is already an adequate fund in CLS the game can be supplied with special brackets for fixing to the ground (option applicable only with confirmation of feasibility).

Make a proper security surface according to CFH. Periodic maintenance is mandatory, following manual supplied to customer.

MATERIALE (mm) MATERIAL (mm)	DESCRIZIONE (mm) DESCRIPTION (mm)	PROFONDITÀ MINIMA (mm) (b) MINIMUM DEPTH (mm) (b)	ALTEZZA MASSIMA DI CADUTA (mm) CRITICAL FALL HEIGHT (mm)
PRATO/TERRICCIO LAWN/SOIL			1000 (d)
CORTECCIA BARK	PEZZATURA DA 20 A 80 20 TO 80 GRAIN SIZE	200	2000
		300	3000
TRUCIOLI DI LEGNO WOOD CHIPS	PEZZATURA DA 20 A 80 20 TO 80 GRAIN SIZE	200	2000
		300	3000
SABBIA SAND	PEZZATURA DA 20 A 80 20 TO 80 GRAIN SIZE	200	2000
		300	3000
GHIAIA GRAVEL	PEZZATURA DA 20 A 80 20 TO 80 GRAIN SIZE	200	2000
		300	3000
PAVIMENTAZIONE IN GOMMA RISPONDENTE A HIC RUBBER SURFACING RESPONDENT TO HIC	SPESSORE/THICKNESS	30mm	1000
		40mm	1300
		45mm	1500
		60mm	2000
		70mm	2500
		90mm	3000
			SOTTOPOSTA A PROVE DI CADUTA DEPENDENT ON CERTIFICATION TESTS